

# IRON WORLD <sup>TM</sup>

Residential, Commercial & Industrial Fencing Solutions

## MAVERICK <sup>TM</sup> SUPREME RESIDENTIAL STEEL



Iron World Manufacturing, LLC, 9390 Davis Avenue, Howard County, Maryland 20723  
Phone: 301-776-7448 | Toll Free: 866-310-2747 | Fax: 301-776-7677

[ironworldfencing.com](http://ironworldfencing.com)





# MAVERICK™ SUPREME RESIDENTIAL STEEL

The Maverick Supreme is targeted for residential applications and provides the beauty and security of iron racked panels constructed with a 15 gauge channel, and 5/8 inch steel pickets. Aluminum strips and stainless steel fasteners are used to attach each individual picket to the rail allowing the section to rack to your job specifications. These strips & fasteners provide the strength of a welded product without the rusting that accompanies them. The following styles are available in Maverick Supreme:



**Aberdeen**

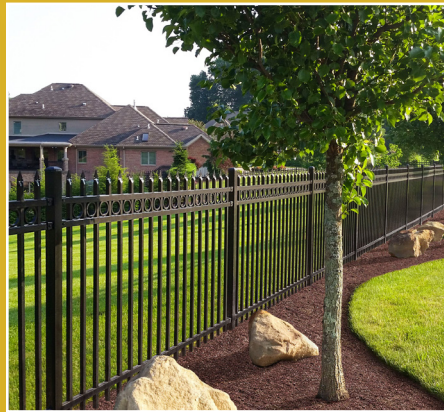

**Barcelona**



**Canterbury**



Two or Three Rails



Two or Three Rail  
Spear Top Pickets



Two or Three Rail  
Flat Top Pickets

- Pickets and rails joined with aluminum strips and stainless fasteners
- Pre-galvanized G60 steel
- Cleansed and phosphate coated for added protection
- Zinc rich primer with durable baked on 2.5-3mm black powder coat finish
- Not wet paint coated which can easily scratch
- Fully assembled and ready to install
- Available in black and custom colors
- Larger post sizes available
- Slide gates and custom entry gates available



## Accessories



## Hardware

Galvanized powder coated brackets with bolts



	Style	Description
	Fence Panels	2 Rail
4'H x 8'W 		
3 Rail		4'H x 8'W *In Stock
		54"H x 8'W 
	5'H x 8'W *In Stock	
		6'H x 8'W *In Stock
	Style	Description
	Steel Posts	16ga Walls
2" x 2" x 6'9"H		
2" x 2" x 7'9"H		
2" x 2" x 8'9"H		
14ga Walls	2" x 2" x 6'H	
	2" x 2" x 7'H	
	2" x 2" x 8'H	
	2" x 2" x 9'H	
	Style	Description
	2 Rail	42"H x 4'W
4'H x 4'W		
3 Rail	4'H x 4'W	
	54"H x 4'W	
	5'H x 4'W	
	6'H x 4'W	

### TECHNICAL DATA FOR INSTALLATION

5/8" steel pickets

15 gauge residential U channel: 1 1/4" x 1 1/16" x 1 1/4" x 94"

94 1/2" face to face with flat bracket

94 1/4" face to face with universal bracket

94 1/4" face to face with line bracket

### RACKED PANEL

36" over 8'

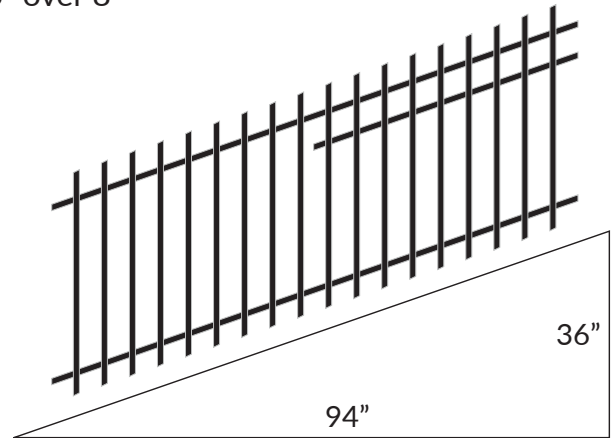

### RESIDENTIAL U-CHANNEL

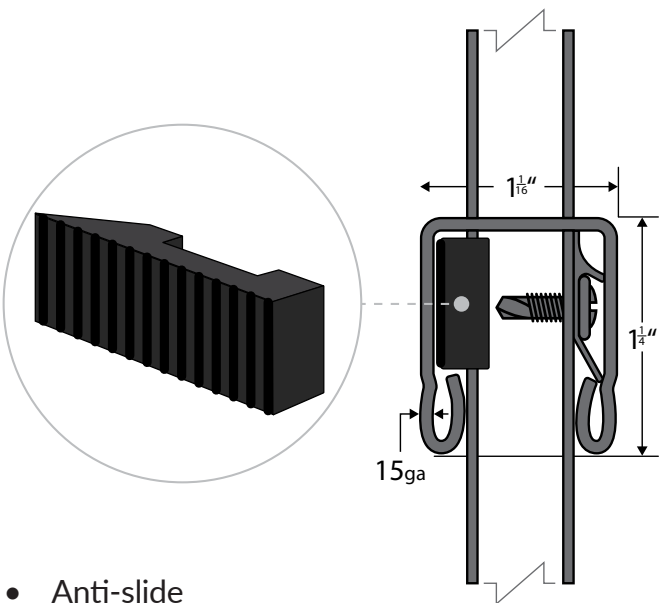

- Anti-slide
- Anti-vibration
- Added security for hidden fasteners
- Aluminum insert and stainless screw, unlike plastic system that break apart and wobble

## IRON SHIELD™

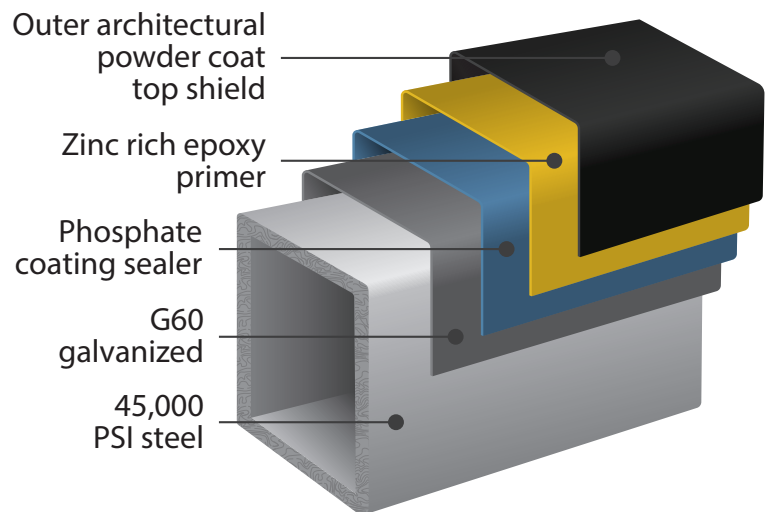

## FLAT TOP WALK GATES

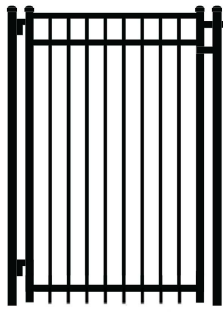

Aberdeen

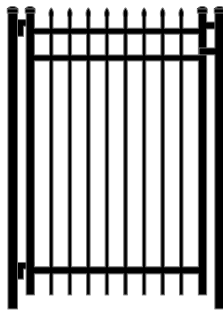

Barcelona

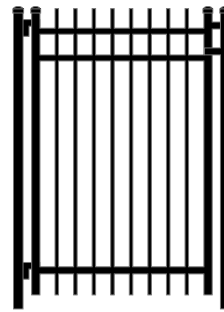

Canterbury

## ARCHED TOP WALK GATES

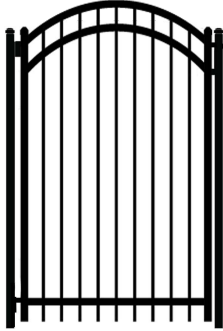

Aberdeen

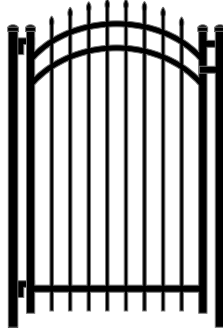

Barcelona

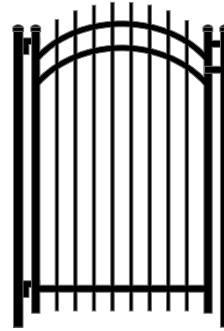

Canterbury

## FLAT TOP DRIVE GATES

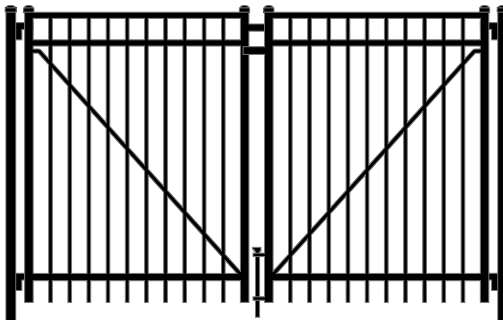

## ARCHED TOP DRIVE GATES

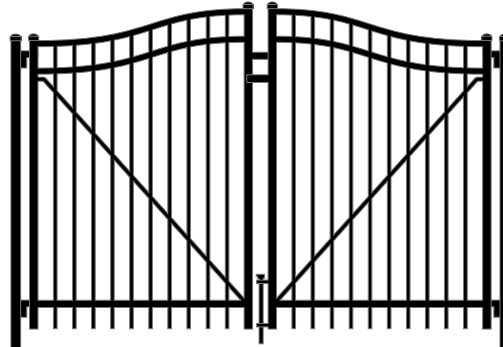

Iron World Manufacturing, LLC  
9390 Davis Avenue  
Howard County, Maryland 20723

Phone: 301-776-7448  
Toll Free: 866-310-2747  
Fax: 301-776-7677

[ironworldfencing.com](http://ironworldfencing.com)

