

NOTES:

1. GATE SHOWN WITH OUR SELF CLOSING STANDARD HARDWARE.
2. OTHER GATE HARDWARE COULD CHANGE LATCH AND HINGE CLEARANCE.
3. ALL HARDWARE SHIPPED LOOSE AND FIELD INSTALLED.

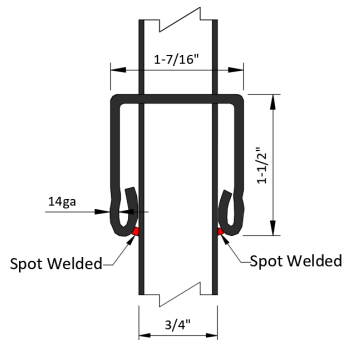

Steel Posts

- 2" x 6' 14ga
- 2" x 7' 14ga
- 2" x 8' 14ga
- 2" x 9' 14ga
- 2 1/2" x 6' 14ga
- 2 1/2" x 7' 14ga
- 2 1/2" x 8' 14ga
- 2 1/2" x 9' 14ga
- 2 1/2" x 11' 14ga

MAVERICK™ SUPREME PLUS COMMERCIAL STEEL

4H X 6W - MSS Commercial Aberdeen-3R Black - STEEL SWING GATE