

- NOTES:
1. GATE SHOWN WITH OUR SELF CLOSING STANDARD HARDWARE.
 2. OTHER GATE HARDWARE COULD CHANGE LATCH AND HINGE CLEARANCE.
 3. ALL HARDWARE SHIPPED LOOSE AND FIELD INSTALLED.

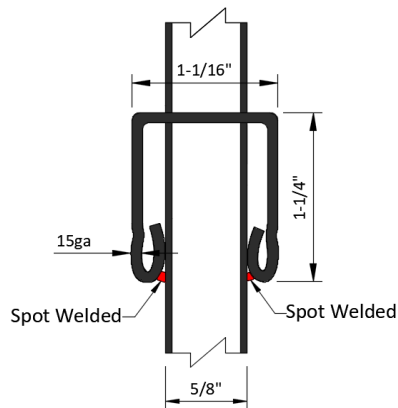

Steel Posts	
□	2" x 2" x 5'9" H
□	2" x 2" x 6'9" H
□	2" x 2" x 7'9" H
□	2" x 2" x 8'9" H

MAVERICK™ SUPREME RESIDENTIAL STEEL

6H X 5W - MSS Canterbury Residential-3R Black - STEEL SWING GATE

PT# MSSRS-RGFT7260C3-BK