

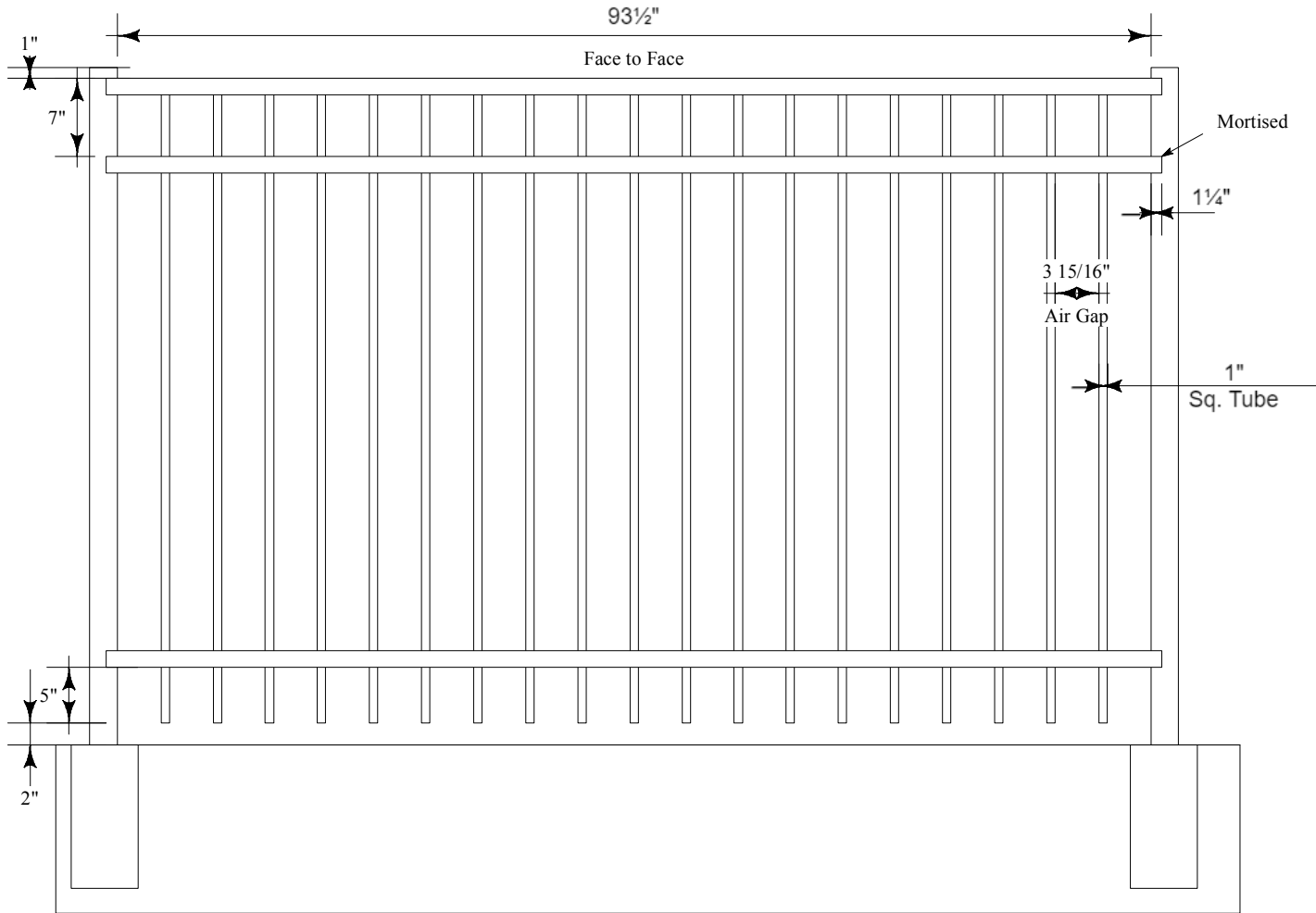

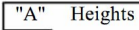



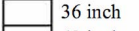

IRON WORLD TM

Residential, Commercial & Industrial Fencing Solutions

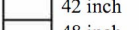
9390 Davis Ave.
 Howard County, MD 20723
 Phone: (301)776-7448
 Fax: (301)776-7677
 Toll Free: (866)310-2747
 www.ironworldfencing.com

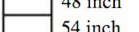

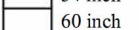
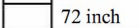
"A"	Heights	"B"	Post	Wall
	36 inch		2 1/2"	Sq. Tube x 0.080"
	42 inch		2 1/2"	Sq. Tube x 0.125"
	48 inch		3"	Sq. Tube x 0.125"
	54 inch		4"	Sq. Tube x 0.125"
	60 inch			
	72 inch			

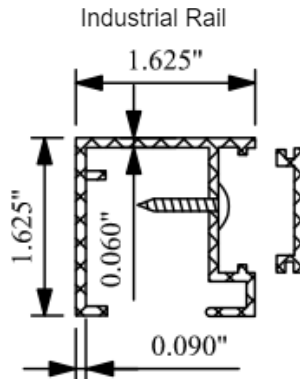

NOTES:

1. INSTALLATION TO BE COMPLETED IN ACCORDANCE WITH MANUFACTURERS SPEC.
2. DO NOT SCALE DRAWINGS.
3. SPECIFICATIONS SHOWN CAN BE CHANGED ONLY BY THE MANUFACTURER.
4. FOOTING WIDTH: (4) X POST WIDTH
FOOTING DEPTH : MINIMUM 24"/RECOMMENDED FREEZE LINE.
5. PANELS SHOWN WITH MORTISED POST SYSTEMS.
6. PANELS ARE RACKABLE WHICH MAY CHANGE FACE-TO-FACE DIMENSION

MAVERICK ULTRA II INDUSTRIAL

Panel width 8' Aberdeen Tradition Bottom 3 Rail Standard