

IRON WORLD TM

MAVERICK ULTRA

Residential, Commercial & Industrial **Aluminum** Fencing Solutions



Iron World Manufacturing, LLC, 9390 Davis Avenue, Howard County, Maryland 20723

Phone: 301-776-7448 | Toll Free: 866-310-2747 | Fax: 301-776-7677

ironworldfencing.com



MAVERICK ULTRA

Residential Grade Aluminum Fence

Maverick Ultra residential grade aluminum fencing offers a classic look of a narrow picket. This grade of aluminum fencing offers a great look and durability for residential pools, backyards and as a decorative perimeter fence. Maverick Ultra aluminum fencing is finished with super durable AAMA 2604 architectural grade powder coat and is warranted against rust, peel, chip, or crack, as long as you own your fence.



RESIDENTIAL ALUMINUM STYLES

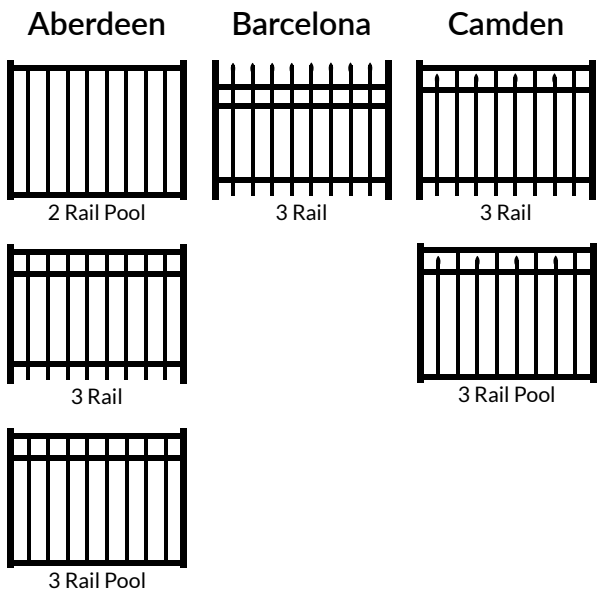

POSTS

- 2" x 2"
- 2" x 2"
- 2-1/2" x 2-1/2"
- 1-1/2" x 2-1/2"

RAILS

- 1"x1" Rail

PICKET SIZE

- 5/8" x 5/8" Picket

PICKET SPACING

- 3-13/16"

PANEL WIDTHS

- 6' (72") wide only

PANEL OPTIONS

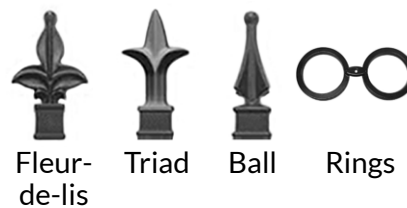

PANEL CHANNEL

- .062 wall
- .125 wall
- .080 wall
- .125 wall
- .080 wall
- .045 wall

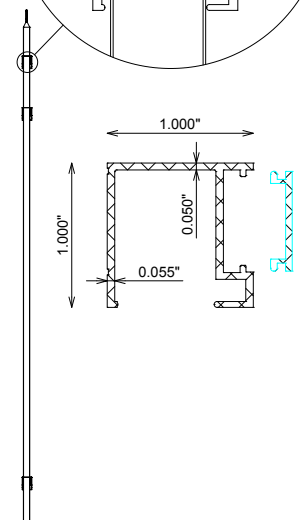
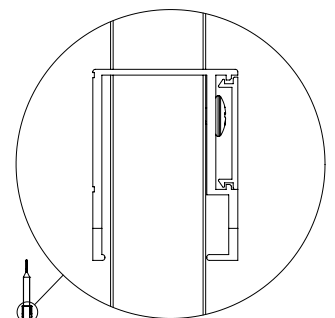

MAVERICK ULTRA PLUS

Commercial Grade Aluminum Fence

Maverick Ultra Plus aluminum fencing is offered in commercial, high-end residential, and perimeter security fencing options. Maverick Ultra Plus works great for commercial pools, estate fencing, golf courses and cemeteries. Maverick Ultra Plus aluminum fencing is finished with super durable AAMA 2604 architectural grade powder coat and is warranted against rust, peel, chip, or crack, as long as you own your fence.

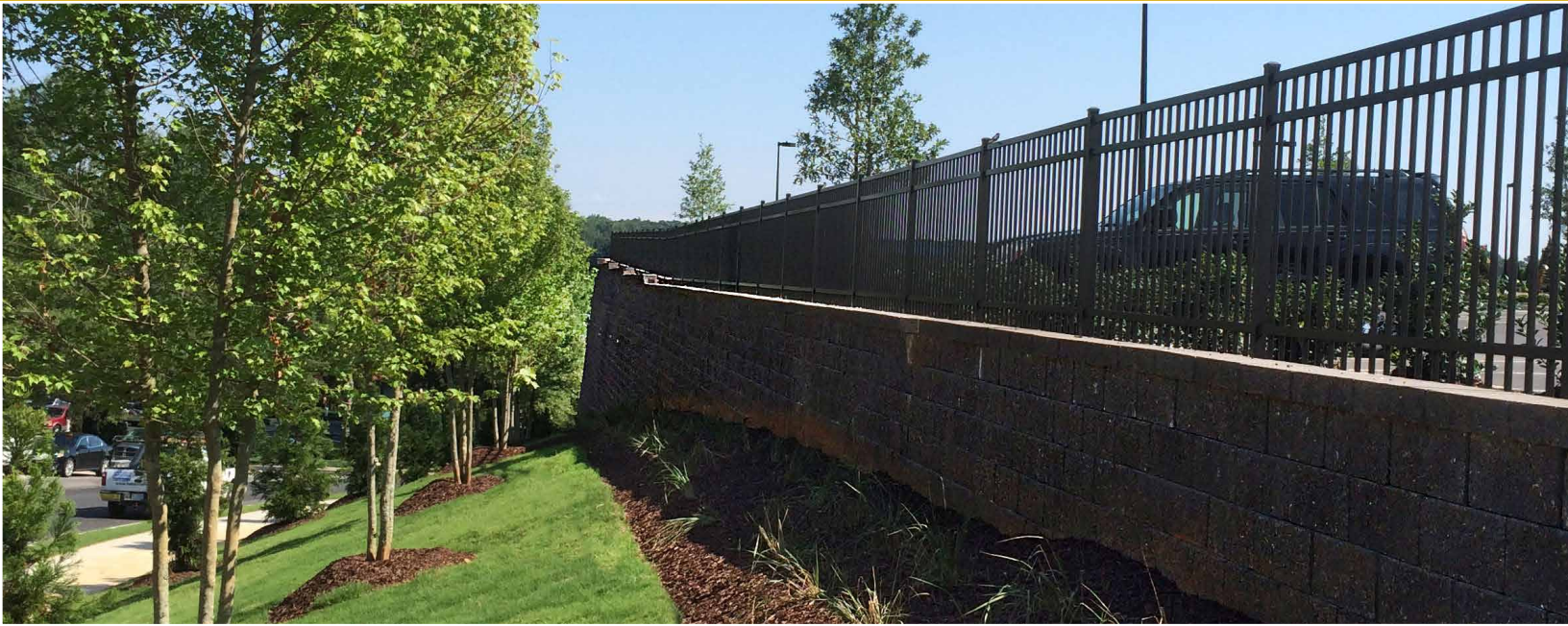

COMMERCIAL ALUMINUM STYLES

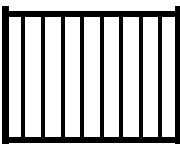
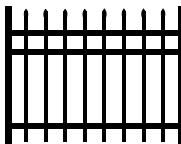
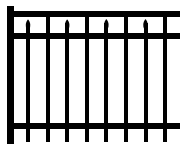
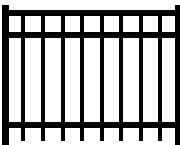
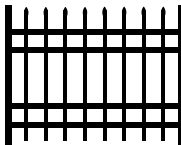
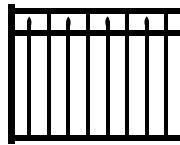
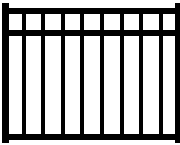
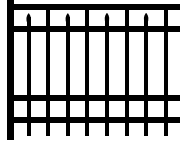
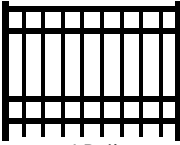
Aberdeen	Barcelona	Camden
 2 Rail Pool	 3 Rail	 3 Rail
 3 Rail	 4 Rail	 3 Rail Pool
 3 Rail Pool		 4 Rail
 4 Rail		

POSTS

- 2" x 2"
- 2" x 2"
- 2" x 2"
- 2-1/2" x 2-1/2"
- 2-1/2" x 2-1/2"
- 3" x 3"

RAILS

- 1-1/2" x 1-1/8"

PICKET SIZE

- 3/4" x 3/4" Picket





PICKET SPACING

- 3-13/16"

PANEL WIDTHS

- 6' (72") and 8' (96")

PANEL OPTIONS

			
Fleur-de-lis	Triad	Ball	Rings

PANEL CHANNEL

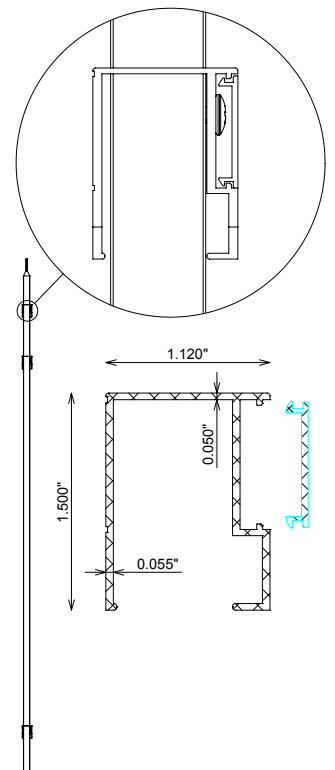

MAVERICK ULTRA II

Industrial Grade Aluminum Fence

Maverick Ultra II industrial grade aluminum fencing is Iron World's strongest, most durable aluminum fence offered. With Iron World's "Heavy" horizontal rails and 1" square pickets this fence will stand the test of time. Maverick Ultra II is the choice for large residential properties, public facilities, storage & commercial properties and security fencing for any commercial / Industrial properties. Maverick Ultra II aluminum fencing is finished with super durable AAMA 2604 architectural grade powder coat and is warranted against rust, peel, chip, or crack, as long as you own your fence.

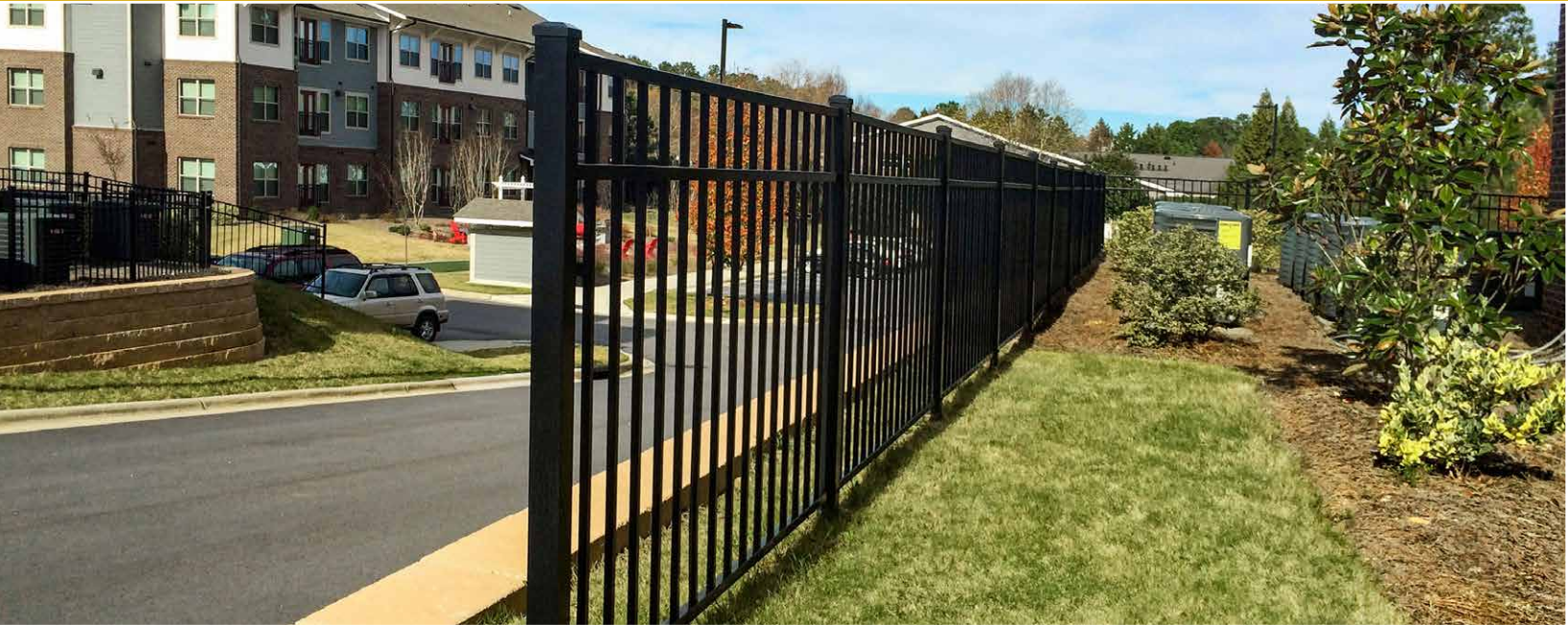

INDUSTRIAL ALUMINUM STYLES

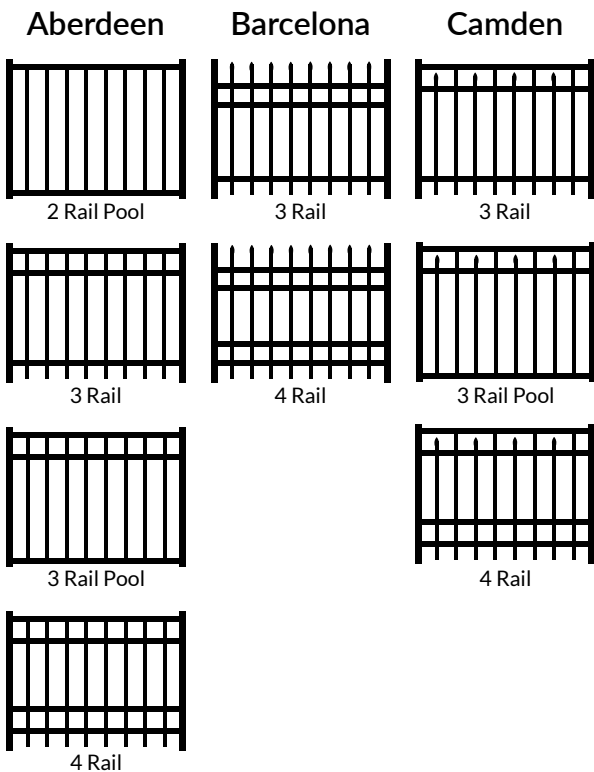

POSTS

2-1/2" x 2-1/2"	.080 wall
2-1/2" x 2-1/2"	.125 wall
3" x 3"	.125 wall
4" x 4" (blank)	.125 wall

RAILS

1-5/8" x 1-5/8" Rail	.100 wall
----------------------	-----------

PICKET SIZE

1" x 1" Picket	.062 wall
----------------	-----------

PICKET SPACING

3-13/16"

PANEL WIDTHS

6' (72") and 8' (96")

PANEL OPTIONS

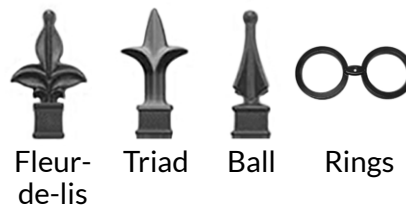

PANEL CHANNEL

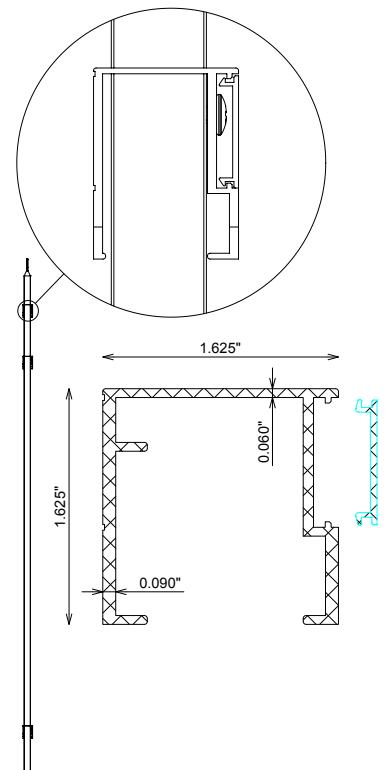

ALUMINUM SWING GATES

Iron World offers a complete line of swing gates (walk and double drive) that offer privacy and security in a multitude of styles. Designed to complement any setting and enhance both commercial and residential properties, Iron World™ swing gates are custom made to precisely fit your opening. All aluminum swing gates can be made using our residential, commercial, or industrial materials. Swing gates can range in size from 3 foot single gates to 40 foot double gates. We offer all styles with rings, finials, and arches.



FLAT TOP WALK GATES

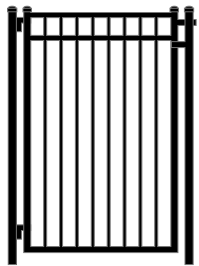

Aberdeen

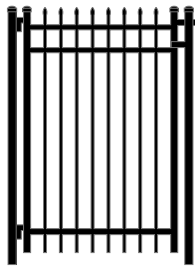

Barcelona



Camden



Canterbury

FLAT TOP DRIVE GATES

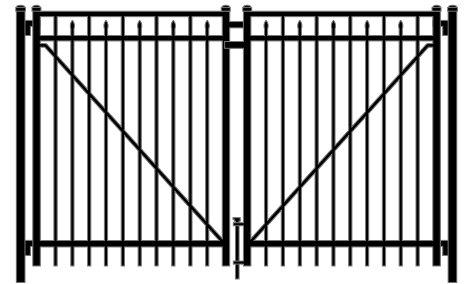

ARCHED TOP WALK GATES

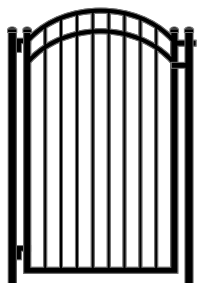

Aberdeen

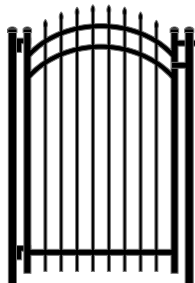

Barcelona



Camden



Canterbury

ARCHED TOP DRIVE GATES

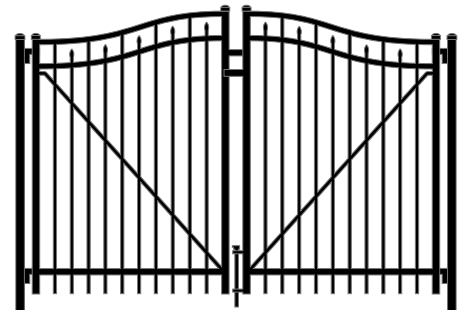

GOLDEN GATE

Slide Gates

Iron World Manufacturing prides itself on producing the BEST slide gates in the industry. With our Golden Gate Series, you get the most up-to-date construction features backed by Iron World's quality reputation for craftsmanship, competitive pricing, short lead times and reasonable shipping. Slide Gates are available in aluminum chain link slider or ornamental powder coated slider. Features include a closed track system with lubricated eight bearing rollers to protect from the elements and guarantee smooth opening and closing.



Picketed Ornamental



Privacy Panel

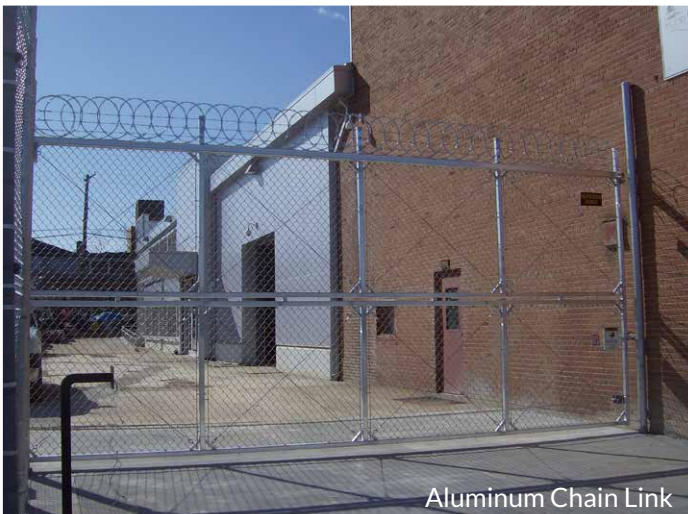

Aluminum Chain Link



Custom Design & Colors

SPECIFICATIONS

- Available in aluminum chain link slider or ornamental powder coated slider
- Features closed track system with lubricated eight bearing rollers to protect from the elements and guarantee smooth opening and closing
- Made from T-6063 aluminum and wired in aluminized fabric or picketed for ornamental projects
- Custom made to fit your needs: arches, rings, finials, etc.
- Made with safety in mind – Automated gate package which meets UL 325 compliance available
- Comes with welded gussets and 1/4 air craft cables for easy adjustment to guarantee smooth operation

SLIDE GATE FEATURES

Lower Roller Guides

- 3/8" solid plate steel
- base/hot dipped galvanized
- 3 1/4" solid rubber wheel w/ball bearing insides

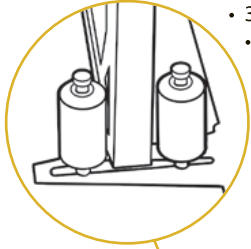

8 Ball Bearing Rollers

- aluminum shaft
- two neoprene side rollers



Truck Bracket

- 3/8" hot dipped galvanized
- 5/8" hole to accept 8" bearing truck assembly

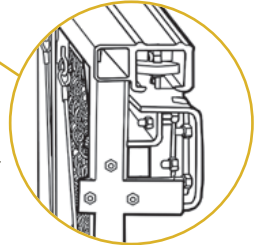

2 x 5 Gate Stop

- hot dipped galvanized
- put at front and back
- ensures gate does not come off rollers

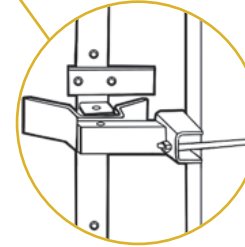

Heavy Duty Gate Receiver

- hot dipped galvanized gate receiver
- guides gate to locking device for secure closure

1" Square Gussets

- 5" big eyebolts
- regulate forces of gate as it opens and closes
- will let you make easy adjustments w/nut under gusset
- 3/8" galvanized aircraft cable throughout gate to ensure stability and adjustment

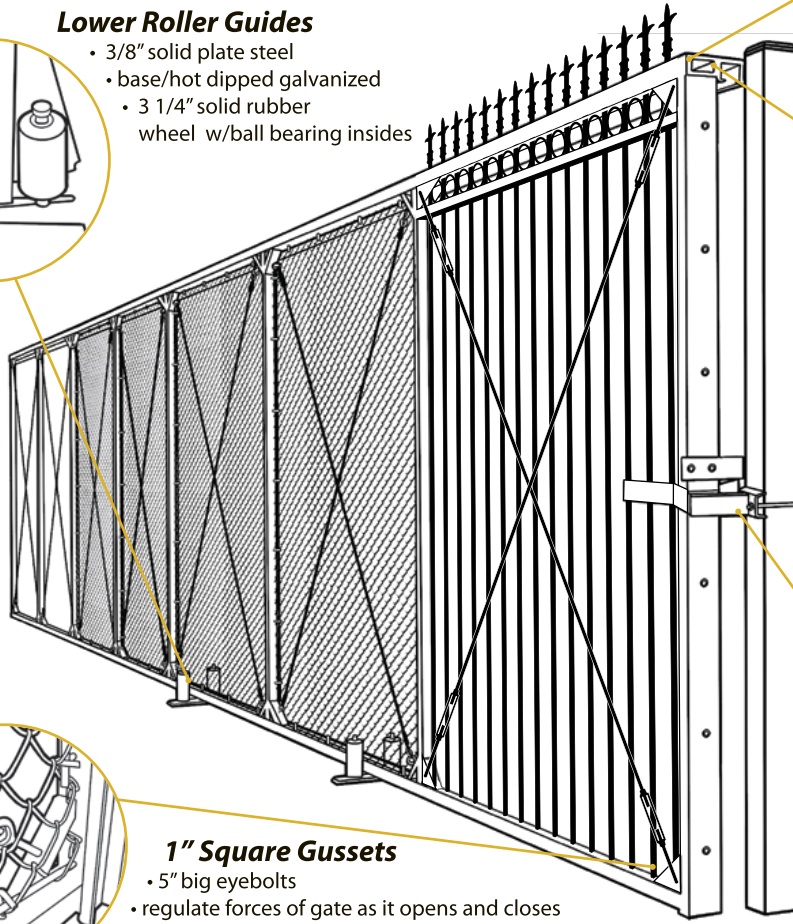
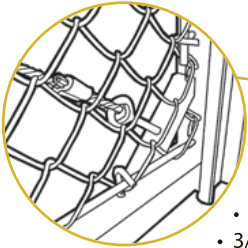

IRON WORLD
FENCING.COM

Panel and Gate Hardware



TruClose® Hinge
Heavy Duty



TruClose® Hinge
Regular



Estate Hinge



LokkLatch®
Deluxe



LokkLatch®
Regular



LokkLatch®
Magnetic Keyed



Gravity Latch



MagnaLatch®
Vertical Pull 10"



MagnaLatch®
Vertical Pull 20"



Aluminum Drop Rod



Flat Bracket



Swivel Bracket

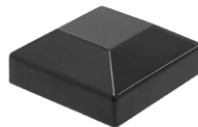

Post Cap



Picket Plug



Fleur de Lis



Triad



Ball



Rings

Iron World Fencing

Iron World Manufacturing is a family owned and operated business established in 2006 in Howard County, Maryland. Today, Iron World Manufacturing has grown into an industry leader in manufacturing ornamental steel and aluminum fence systems, gates and polyester coated pipe. Iron World is proud and grateful to have over 100 dedicated employees that take pride in manufacturing quality American made products.

Iron World Manufacturing is one of the fastest growing manufactures of Ornamental Fencing in the Country. With pride we stand behind and offer warranties on all of our products. Our world class fence systems, gates and polyester coated pipe meet the highest standards of quality, durability and functionality. All of the products we offer are manufactured in the U.S.A. and offer beauty, strength and security.



Our mission is to provide superior products and service to all of our Residential, Commercial and Industrial customers at a competitive price. Iron World Manufacturing strives to be at the forefront of ornamental fence manufacturing and powder coating technology. Our commitment to customer service is never sacrificed as we treat each and every customer as a valued partner.



Call Iron World Manufacturing today to speak with our knowledgeable sales representatives.
(866)310-2747

Specifications

Components	Maverick Ultra	Maverick Ultra Plus	Maverick Ultra II
Pickets (Size and Wall Thickness)	5/8sq x .050	3/4sq x .050	1"sq x .062
Rails: Side Walls	1.00" x 1.00" Triple .080	1.50" x 1.20" Triple .080	1.50" x 1.20" Triple .100
Pickets 6' Wide Sections	15	14	13
Pickets 8' Wide Sections	N/A	19	19
Post Standards	2" x 2" x .062	2" x 2" x .080 2 1/2" x 2 1/2" x .080 2 1/2" x 2 1/2" x .125 3" x 3" x .125	2 1/2" x 2 1/2" x .080 2 1/2" x 2 1/2" x .125 3" x 3" x .125
Post Gate	2" x 2" x .125 2 1/2" x 2 1/2" x .125 3" x 3" x .125 4" x 4" x .125	2" x 2" x .125 2 1/2" x 2 1/2" x .125 3" x 3" x .125 4" x 4" x .125	2 1/2" x 2 1/2" x .125 3" x 3" x .125 4" x 4" x .125
Picket Spacing	<4" TYP.	<4" TYP.	<4" TYP.
Standard Heights	36", 42", 48", 54", 60", 72"	36", 42", 48", 54", 60", 72"	36", 42", 48", 54", 60", 72", 84", 96"
Alloy	6063/T5 alloy on pickets, posts, and rails. 6005/T5 alloy available on posts.	6063/T5 alloy on pickets, posts, and rails. 6005/T5 alloy available on posts.	6063/T5 alloy on pickets, posts, and rails. 6005/T5 alloy available on posts.



IRON SHIELD

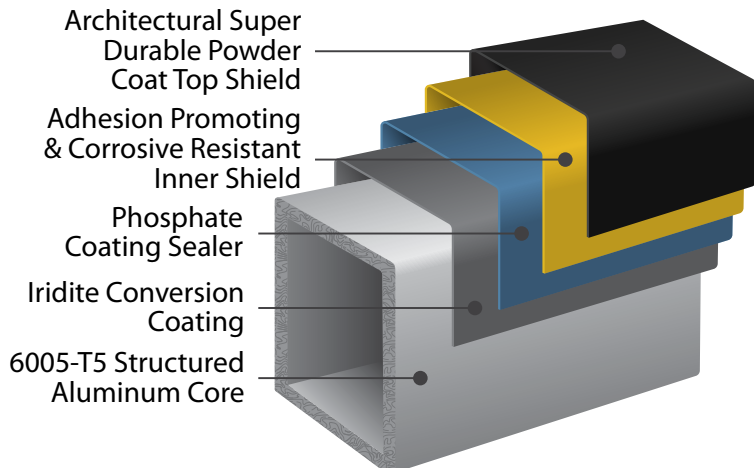

Process



Iron World powder coats all pickets, channels and posts loose rather than assembled to ensure 100 percent powder coating coverage of all parts.



We package all panels, posts, and gates on skids with vinyl clips in between each panel to ensure no scratching. Then we wrap and heat shrink it to ensure your product gets to you damage free.

Lifetime Limited Warranty

Iron World Mfg. warrants to the original owner that all of our products will be free of manufacturing and material defects. Our powder coating finish on our aluminum fences will not peel, crack, chip, or blister for as long as you own the fence.

This warranty does not cover damages cause by improper use, application, or installation; abuse; alterations; negligence; vandalism; or acts of God. The warranty also does not extend to the normal weathering, slight discoloration, or chalking caused by prolonged exposure to the elements, mildew, or air pollution. There is no other express warranty except that stated herein.

This lifetime warranty is intended to cover original owners only and is not transferable. The original owner is covered by the warranty for as long as he owns and resides in the property on which the product was first installed. In the event of commercial or otherwise non-residential use, Iron World limits this product warranty to 20 years with a starting date of the original day of installation.

In case of a warranty claim, the owner must provide Iron World a written notice specifying the nature of the defect, along with proof of purchase, within 20 days of the failure. Iron World reserves the right to inspect the material in question to determine the validity of the claim. Defective material must be shipped to Iron Worlds facility for inspection freight pre-paid. If the product fails to conform to this warranty, Iron World will replace or repair the defective material at its discretion. Iron World shall not be liable or responsible for labor charges or other expenses whatsoever in connection with removal or installation of either the original or replacement product.

The above constitutes the complete limited lifetime warranty by Iron World and no other agreement, written or implied, is valid. No person is authorized to change or modify this warranty. Recoveries for consequential or incidental damages are hereby excluded.

Iron World Management



Iron World Manufacturing Family of Products



IRON WORLD™
Residential, Commercial & Industrial Fencing Solutions

MAVERICK ULTRA
Residential, Commercial & Industrial Aluminum Fencing Solutions



Iron World Manufacturing, LLC, 9390 Davis Avenue, Howard County, Maryland 20723
Phone: 301-776-7448 | Toll Free: 866-310-2747 | Fax: 301-776-7677
ironworldfencing.com

LIFETIME LIMITED WARRANTY **POWDER COATED TOUGH** **MADE IN THE USA**

Maverick Ultra fencing panels and gates are manufactured in three grades for residential, commercial, and industrial applications.



IRON WORLD™
Residential, Commercial & Industrial Fencing Solutions

MAVERICK SUPREME



Iron World Manufacturing, LLC, 9390 Davis Avenue, Howard County, Maryland 20723
Phone: 301-776-7448 | Toll Free: 866-310-2747 | Fax: 301-776-7677
ironworldfencing.com

LIFETIME LIMITED WARRANTY **POWDER COATED TOUGH** **MADE IN THE USA**

Maverick Supreme is targeted for residential applications and provides the beauty and security of stainless steel raked panel with hidden fastener system.



IRON WORLD™
Residential, Commercial & Industrial Fencing Solutions

IRON CURTAIN



DO IT RIGHT THE FIRST TIME WITH IRON WORLD IRON CURTAIN STEEL PRIVACY PANELS WITH A 20 YEAR WARRANTY

Iron World Manufacturing, LLC, 9390 Davis Avenue, Howard County, Maryland 20723
Phone: 301-776-7448 | Toll Free: 866-310-2747 | Fax: 301-776-7677
ironworldfencing.com

All IW 40 products from Iron World Mfg. are manufactured in the USA and are in compliance with federal, state and local specifications. We meet "Buy American" requirements. **MADE IN THE USA**

Iron Curtain provides maintenance free privacy with an industrial level of quality using 11 gauge steel channels to house 25 gauge interlocking galvanized boards.



IRON WORLD™
Residential, Commercial & Industrial Fencing Solutions

IRON WORLD MANUFACTURING COMMERCIAL & INDUSTRIAL IW 40 GALVANIZED FENCE FRAMEWORK



DELIVERING THE HIGHEST QUALITY FENCE FRAMEWORK.

Iron World Manufacturing, LLC, 9390 Davis Avenue, Howard County, Maryland 20723
Phone: 301-776-7448 | Toll Free: 866-310-2747 | Fax: 301-776-7677
ironworldfencing.com

All IW 40 products from Iron World Mfg. are manufactured in the USA and are in compliance with federal, state and local specifications. We meet "Buy American" requirements. **MADE IN THE USA**

Iron Shield Polyester & Iron Guard Galvanized IW 40 fence framework provides a combination of high strength steel and corrosive resistance.



Iron World Manufacturing, LLC
9390 Davis Avenue, Howard County, Maryland 20723
Phone: 301-776-7448 | Toll Free: 866-310-2747 | Fax: 301-776-7677

ironworldfencing.com